

Data Sheet



Article number: 604144026050

Description: Timing belt pulley with hub
HTD 26 8M 50

Measures

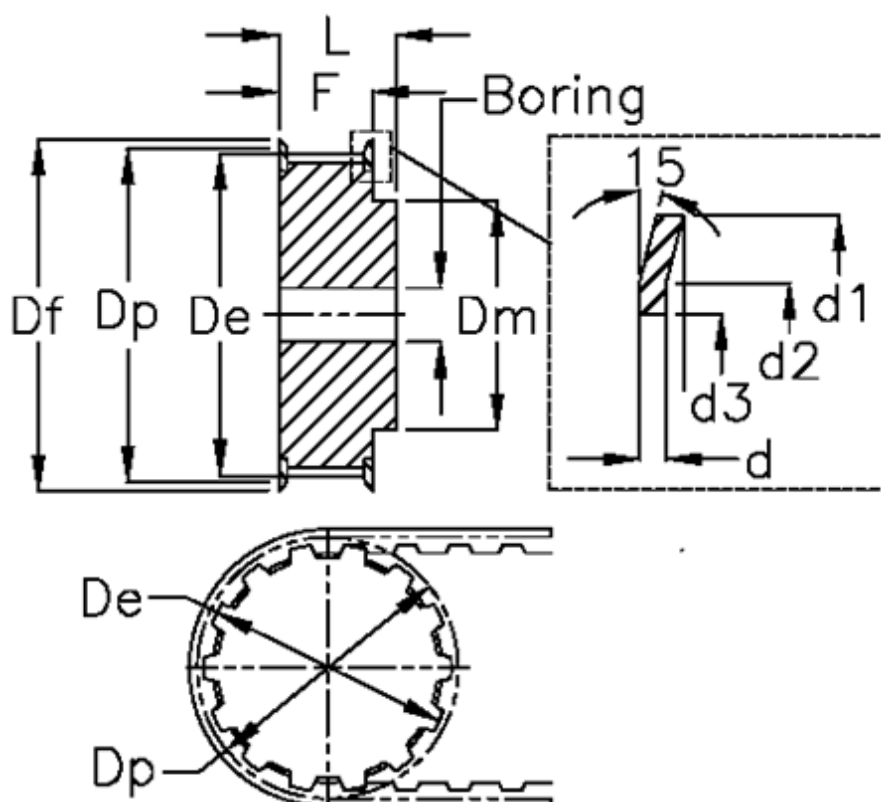

Bore = 15	Dp = 66.21
d = 1.5	F = 60
d1 = 70	Flange type = F26
d2 = 66.5	L = 70
d3 = 53	Tooth number = 26
De = 64.84	Type = 8M
Df = 70	Weight = 1.5
Dm = 48	Width = 50